

STRAIGHT MALE RECEPTACLE PIN IN PASTE
FULL DETENT-TAPE AND REEL BY 500

R222.940.100

Series : SMP-COM

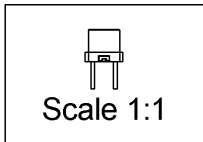
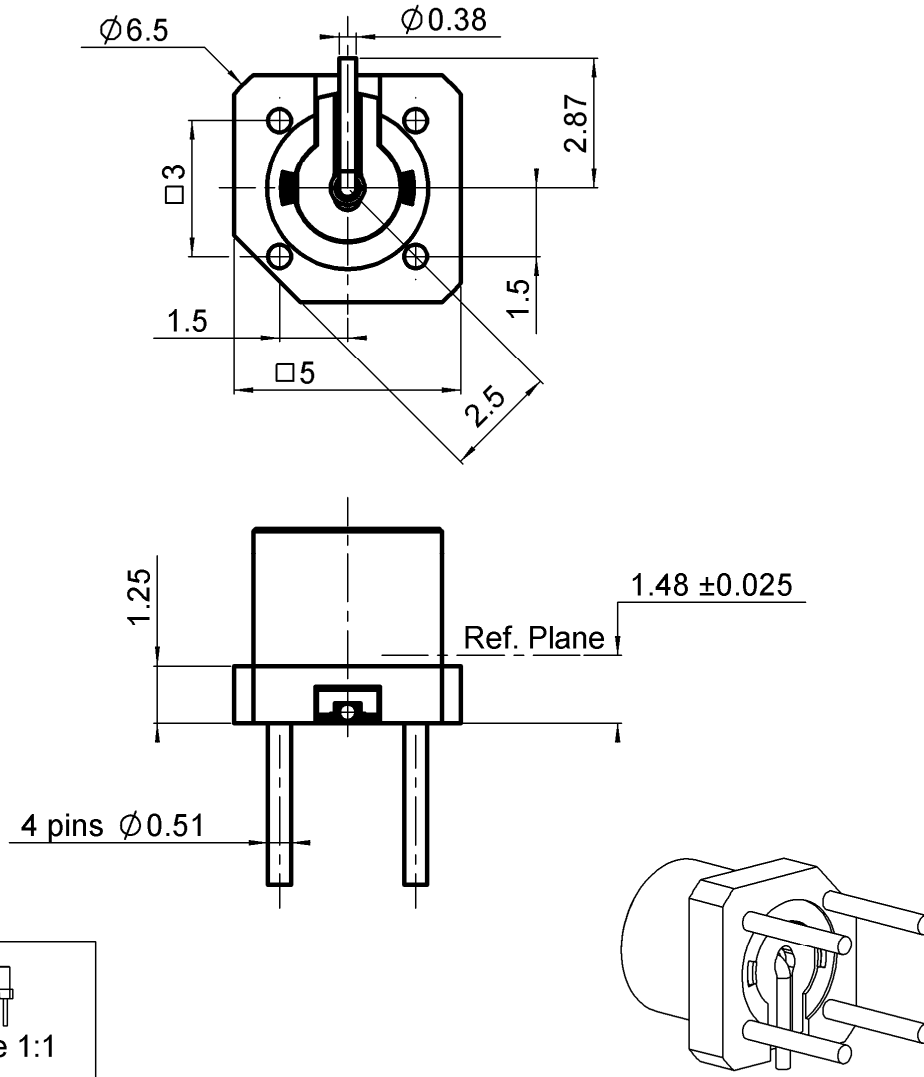

All dimensions are in mm.

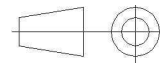

COMPONENTS	MATERIALS	PLATING (µm)
BODY	BRASS	NPGR
CENTER CONTACT	BRASS	NPGR
OUTER CONTACT	-	-
INSULATOR	PEEK	-
GASKET	-	-
OTHERS PARTS	-	-
-	-	-
-	-	-

Issue : 0949 C

In the effort to improve our products, we reserve the right to make changes judged to be necessary.



STRAIGHT MALE RECEPTACLE PIN IN PASTE

R222.940.100

FULL DETENT-TAPE AND REEL BY 500

Series : SMP-COM

PACKAGING

SPECIFICATION

Standard	Unit	Other
500	'W' option	Contact us

ELECTRICAL CHARACTERISTICS

ENVIRONMENTAL

Impedance	50	Ω
Frequency	0-12.4*	GHz
VSWR	1.1** + 0,0000	x F(GHz) Maxi
Insertion loss	0.12	\sqrt{F} (GHz) dB Maxi
RF leakage	- (NA)	- F(GHz)) dB Maxi
Voltage rating	335	Veff Maxi
Dielectric withstanding voltage	500	Veff mini
Insulation resistance	5000	M Ω mini

Operating temperature	-55/+125	$^{\circ}$ C
Hermetic seal	NA	Atm.cm3/s
Panel leakage	NA	

OTHER CHARACTERISTICS

Assembly instruction **NA**

Others :

*ROS 1.35 at 6GHz

**ROS at 6GHz

MECHANICAL CHARACTERISTICS

Center contact retention		
Axial force – Mating end	6.8	N mini
Axial force – Opposite end	6.8	N mini
Torque	NA	N.cm mini
Recommended torque		
Mating	NA	N.cm
Panel nut	NA	N.cm
Mating life	100	Cycles mini
Weight	0,3650	g

Issue : 0949 C

In the effort to improve our products, we reserve the right to make changes judged to be necessary.



STRAIGHT MALE RECEPTACLE PIN IN PASTE
FULL DETENT-TAPE AND REEL BY 500

R222.940.100

Series : SMP-COM

SOLDER PROCEDURE

1. Deposit solder paste ‘SnAg4Cu0.5’ on mounting zone by screen printing application. We recommend a low residue flux.
We advise a thickness of 150 micromm (5.850 microinch). Verify that the edges of the zone are clean.
2. Placement of the receptacle on the mounting zone with an automatic machine of ‘pick and place’ type. A video camera is recommended for positioning of the component . Adhesive agents must not be used on the receptacle.
3. This process of soldering has been tested with convection oven .Below please find ,the typical profile to use.
4. The cleaning of printed circuit boards is not obliged .
5. Verification of solder joints and position of the component by visual inspection.

TEMPERATURE PROFILE

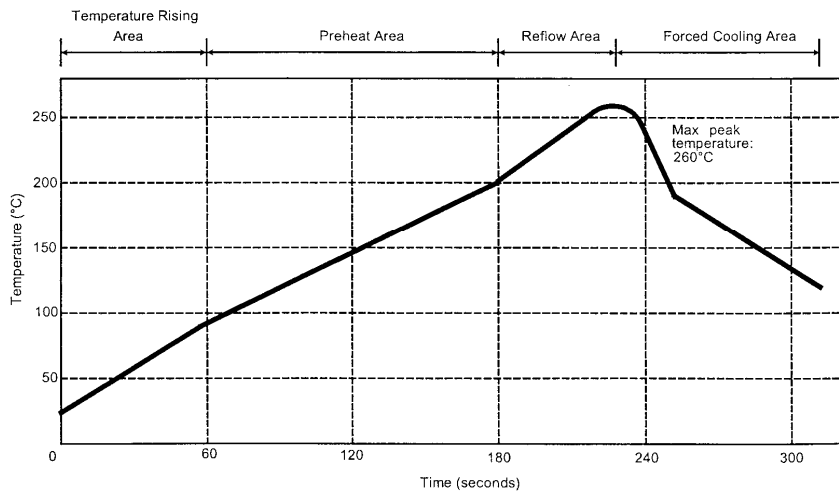

Parameter	Value	Unit
Temperature rising Area	1 - 4	°C/sec
Max Peak Temperature	260	°C
Max dwell time @260°C	10	sec
Min dwell time @235°C	20	sec
Max dwell time @235°C	60	sec
Temperature drop in cooling Area	-1 to - 4	°C/sec
Max dwell time above 100°C	420	sec

Issue : 0949 C

In the effort to improve our products, we reserve the right to make changes judged to be necessary.



STRAIGHT MALE RECEPTACLE PIN IN PASTE

FULL DETENT-TAPE AND REEL BY 500

R222.940.100

Series : SMP-COM

STANDARD PAD(F or ROGERS 4350)

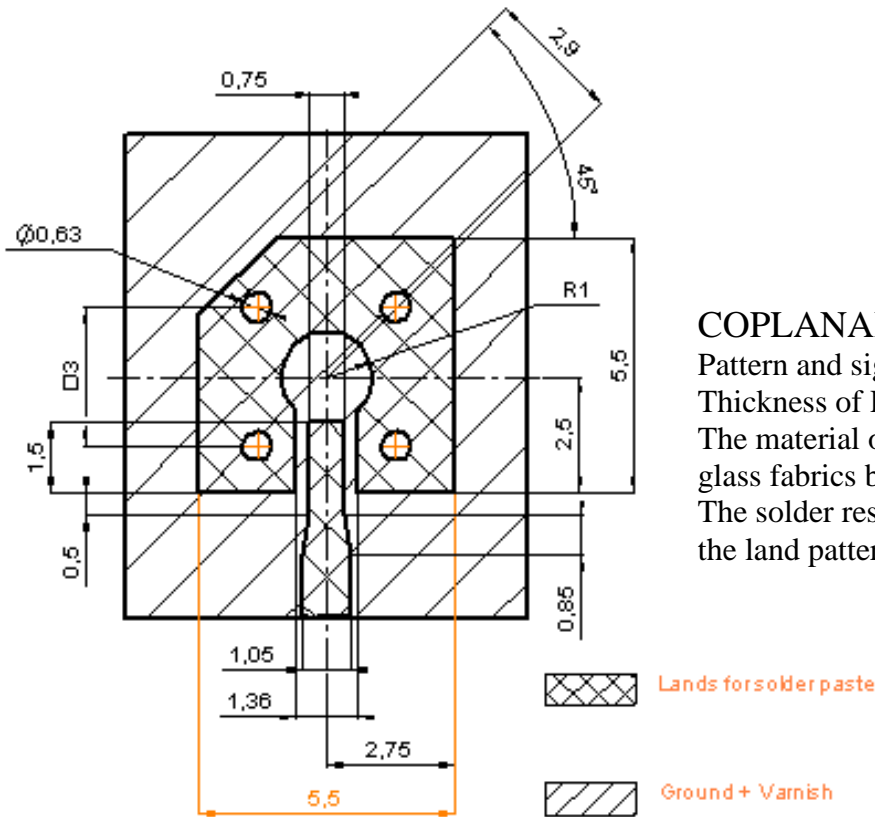

COPLANAR LINE

Pattern and signal are on the same side.

Thickness of PCB : 1.6mm

The material of PCB is the epoxy resin of glass fabrics bacs (ER:4.8).

The solder resist should be printed except for the land pattern on the PCB.

SHADOW OF RECEPTACLE FOR VIDEO CAMERA

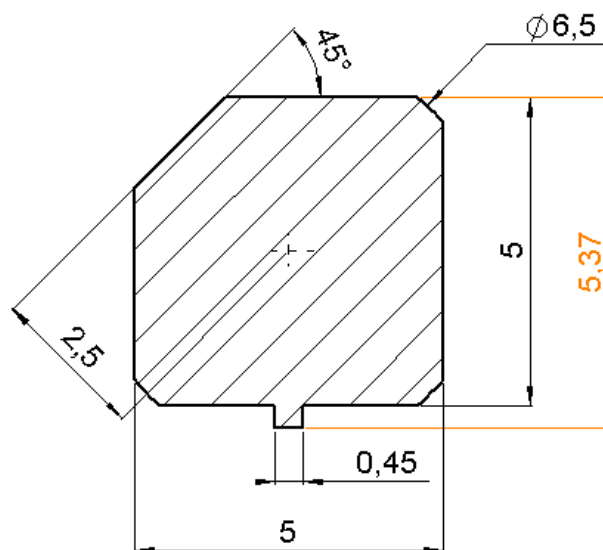

Issue : 0949 C

In the effort to improve our products, we reserve the right to make changes judged to be necessary.



STRAIGHT MALE RECEPTACLE PIN IN PASTE

FULL DETENT-TAPE AND REEL BY 500

R222.940.100

Series : SMP-COM

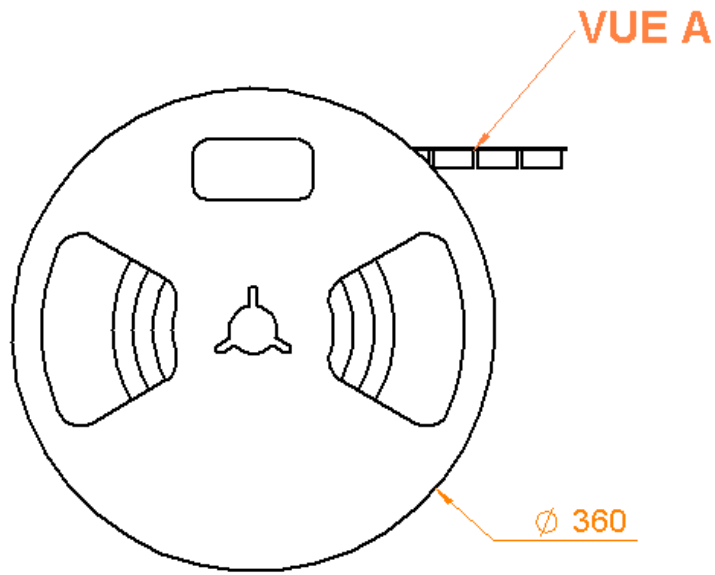

AIR SUNCTION

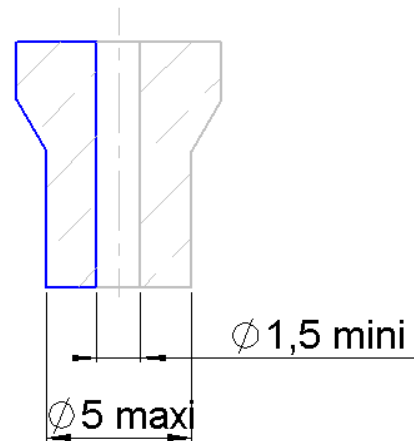
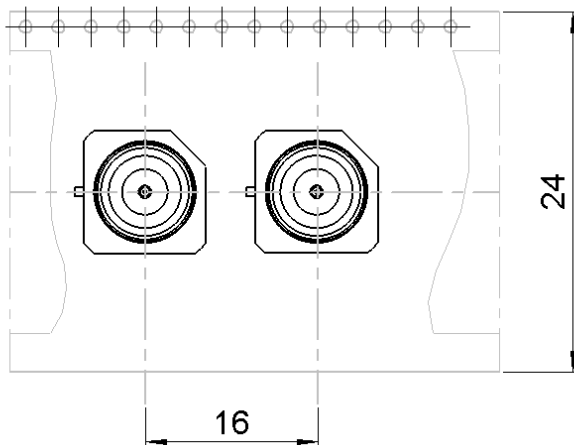

Issue : 0949 C

In the effort to improve our products, we reserve the right to make changes judged to be necessary.

